

HASRAF[®]

www.hasraf.com



Müşterilerinin ihtiyaçları doğrultusunda uygun çözümler üreten HASRAF Raf Sistemleri olarak 1984 yılında civatalı çelik raf üretimi ile sektördeki yerimizi aldık. Kalite ve güvenilirlikten ödün vermeden hedeflerini gerçekleştirme doğrultusunda emin adımlar atan şirketimiz geçen sürede çelik rafının yanı sıra ahşap ve metal dekoratif raf sistemlerini de bünyesine ekleyerek büyümüştür. Kendini kanıtlamış kurumlara hizmet veren şirketimiz, üretiminin %60'ını yurt dışına ihrac ederek ülke ekonomisine de katkıda bulunmayı amaç edinmiştir. Şirketimiz bu gün 17 ülkede bayilikleri ile bir çok ülkeye ürün ihracatı yaparak yer aldığı sektörü geliştirmek konusunda önemli adımlar atmaktadır. HASRAF Raf Sistemleri olarak, proje aşamasından montaj sürecinin sonuna kadar sorumluluğunu üstlendiğimiz tüm işleri en kısa sürede, en ekonomik koşullarda ve en güvenilir şekilde teslim etmek öncelikli hedefimizdir.

MİSYONUMUZ

HASRAF, Türkiye'de hızla gelişen perakende sektöründe, market ve mağazalar zincirlerinin teşhir ve raf sistemleri ihtiyacını, modern bir anlayışla, tüketici ihtiyaç ve isteklerini azami ölçüde karşılayacak bir estetik yaklaşımla ve konusunda uzman, tecrübeli bir teknik kadroyla karşılanmasını kuruluşunun misyonu olarak benimsemiştir.

VİZYONUMUZ

Globalleşen dünya ve artan dünya ticaret hacmi içinde Türkiye'nin daha etkin bir rol alması gerekliliğine inanan HASRAF, bu güne kadar iç piyasada gerçekleştirdiği başarılı projeleri yurt dışına da taşımak için ihracata odaklı bir gelişim stratejisi izlemektedir. HASRAF, son teknoloji kullanan, tecrübeli ve uzman bir ekibi bünyesinde barındıran, gerçek manada müşteri odaklı yaklaşımı kurum kültürünün merkezini yerleştiren bir anlayışla, gerek iç piyasada gerekse yurt dışında mağaza ekipmanları konusunda, mağaza teşhir sistemleri ve depo istifleme raf sistemleri ile sektörüne yeni ve çağdaş bir bakış açısı kazandırmayı hedeflemektedir.

As HASRAF Shelf Systems, which produces suitable solutions according to the needs of its customers, we took our place in the industry in 1984 with the production of bolted steel shelves. Our company, taking confident steps towards achieving its goals without compromising on quality and reliability, has grown over time by incorporating wooden and metal decorative shelf systems alongside its steel shelves. Serving established institutions, our company aims to contribute to the country's economy by exporting 60% of its production abroad. Today, our company, with dealerships in 17 countries, exports products to many countries, contributing to the advancement of the industry in which it operates. As HASRAF Shelf Systems, we undertake responsibility for all projects from the project phase to the end of the assembly process and our primary goal is to deliver all tasks in the shortest time, under the most economical conditions, and in the most reliable manner.

OUR MISSION

HASRAF has embraced as its mission the fulfillment of display and shelving system needs for supermarkets and retail chains in the rapidly evolving retail sector in Turkey. With a modern approach that maximally caters to consumer needs and desires, and with an aesthetic perspective, HASRAF is committed to meeting these needs through a specialized and experienced technical team.

OUR VISION

Globalizing world and increasing world trade volume Turkey taking a more active role in HASRAF, believing in the necessity of successful projects realized in the market An export-oriented development to move abroad strategy is followed. HASRAF, using the latest technology, Incorporating an experienced and expert team, a truly customer-oriented approach with an understanding that places the center of its culture, stores in the domestic market and abroad. equipment, shop display systems and warehouse stacking rack systems and provide a contemporary perspective, aims to.

İÇİNDEKİLER

INDEX

1-5

**METAL
REYONLAR**
METAL UNITS



5-8

**YAPI
MARKET**
DIY MARKET

9-10

**KOZMETİK VE SEMİREK
REYONU**
COSMETICS AND SEMİREK UNITS

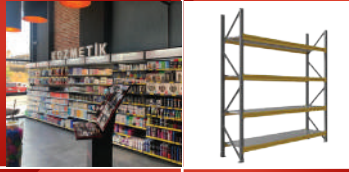

11-18

**HAFİF-MİNİ RACK
RAF SİSTEMLERİ**
LIGHT-MINI RACK RACK SYSTEMS
GROSS MARKETLER
GROSS MARKETS

19-22

**MANAV
REYONLARI**
VEGETABLES UNITS

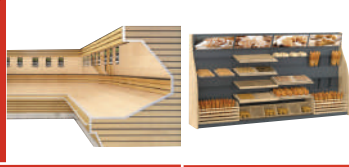

23-24

**UNLU
MAMÜLLER**
BAKERY UNITS

25-28

**ZÜCCACİYE / OYUNCAK
REYONLARI**
GLASSWARE / TOY UNITS

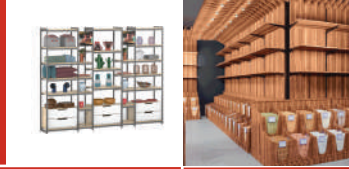

29-34

**BAKLİYAT / KURUYEMİŞ
REYONULARI**
LEGUMES / NUTS UNITS

35-39

**KIRTASIYE
REYONLARI**
STATIONERY UNITS



40

**AHŞAP - BANKO
MÜŞ. KABUL**
WOODEN - COUNTER RECEPTION

41-48

**YAZAR KASA MASALARI
TURNİKE VE BARIYER**
CHECKOUTS TURNSTILE and BARRIER



49-50

MARKET ARABALARI
SHOPPING TROLLEYS

51-52

PROMOSYON SEPETLER
PROMOTION BASKETS
YÜK ARABALARI
LOGISTIC TROLLEYS



53-54

PETROL REYONLARI
OIL UNITS



HAS 168

UNIT DIMENSIONS

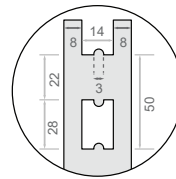
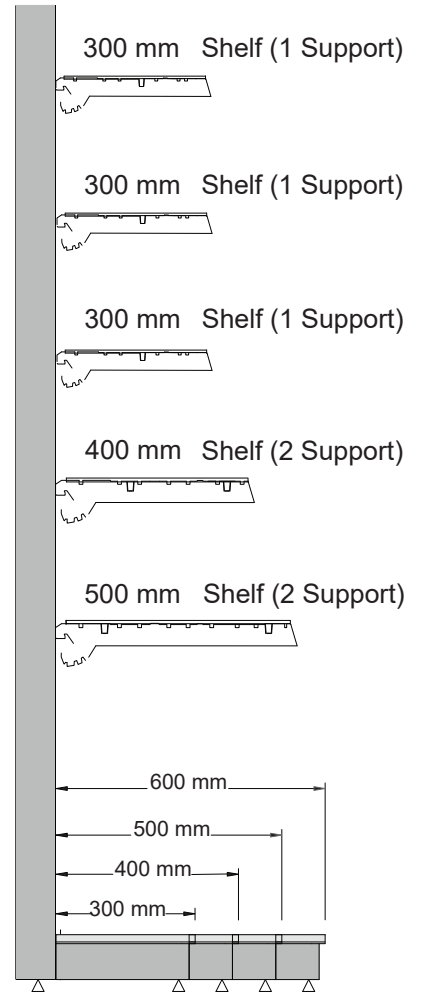

P 50

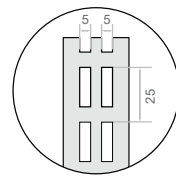

P 25

POWDER COATING FEATURES

Electrostatic Epoxy Polyester Powder Paint

- RAL 9016
 - RAL 3000
 - RAL 7040
 - RAL 1018
 - RAL 7016
 - RAL 5002
 - RAL 9005
 - RAL 6018
 - RAL 2008
- Alternative color work can be done in line with the customer's request.

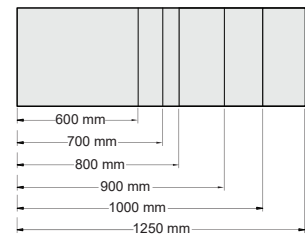

						H:2900mm	
						h:400 mm	
					H:2500mm	h:400 mm	
					h:400 mm	h:400 mm	
				H:2200mm	h:400 mm	h:400 mm	
				H:2100mm	h:400 mm	h:400 mm	
			H:2000mm	h:400 mm	h:400 mm	h:400 mm	
		H:1730mm	h:300 mm	h:400 mm	h:400 mm	h:400 mm	
		h:400 mm	h:400 mm	h:400 mm	h:400 mm	h:400 mm	
	H:1330mm	h:400 mm	h:400 mm	h:400 mm	h:400 mm	h:400 mm	
	h:400 mm	h:400 mm	h:400 mm	h:400 mm	h:400 mm	h:400 mm	
H:930 mm	h:400 mm	h:400 mm	h:400 mm	h:400 mm	h:400 mm	h:400 mm	
h:400 mm	h:400 mm	h:400 mm	h:400 mm	h:400 mm	h:400 mm	h:400 mm	
h:400 mm	h:400 mm	h:400 mm	h:400 mm	h:400 mm	h:400 mm	h:400 mm	

Orta Reyonlar



Çiftli Orta Reyon / Double Middle Unit

Ölçü / Size

H: 1430-1730

P: 300-400-500-600

L: 600-700-800-900-1000-1250

HAS
33

Gondolbaşı Reyon / Head Gondole Unit

Ölçü / Size

H: 1430-1730

P: 300-400-500-600

L: 600-700-800-900-1000-1250



HAS
30

Oval Gondolbaşı Reyon / Oval Head Gondole Unit

Ölçü / Size

H: 1430-1730

P: 300-400-500-600

L: 600-700-800-900-1000-1250

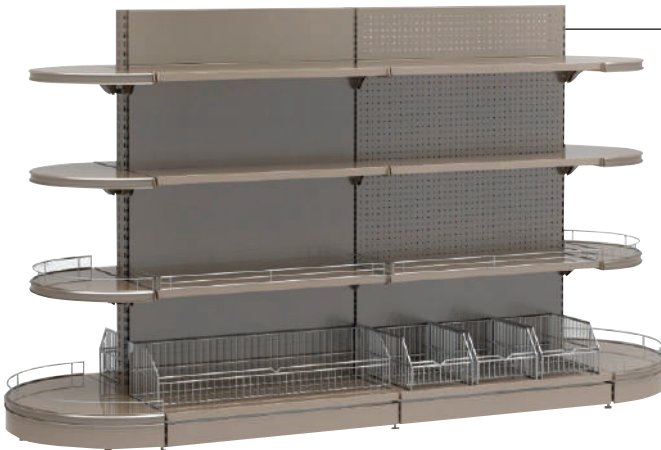



DIŐ KŐŐE DUVAR ÜNİTESİ

(WALL UNIT
INTERIOR CORNER)



İÇ KŐŐE DUVAR ÜNİTESİ

(WALL UNIT
EXTERIOR CORNER)



KAPI REYON ÜNİTESİ

(DOOR SECTION
UNIT)

www.hasraf.com

4

Reyon Bileşenleri

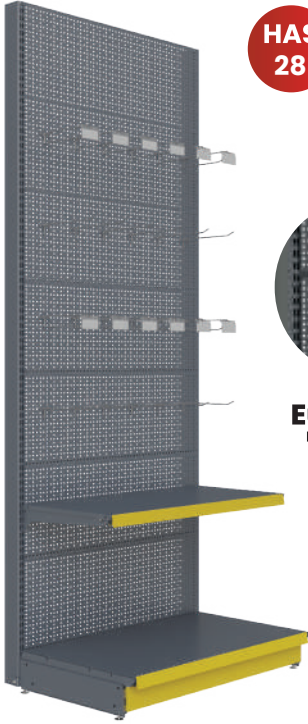

HAS
28

Euro Delik
Euro Perforated



HAS
29

Tel Rafıli Reyon



HAS
202

Kutu Profilli Reyon

Hırdavat Reyon / Hardware Unit

Ölçü / Size

H: 1430-1730-2230 P: 300-400-500-600

L: 600-700-800-900-1000

HAS
91

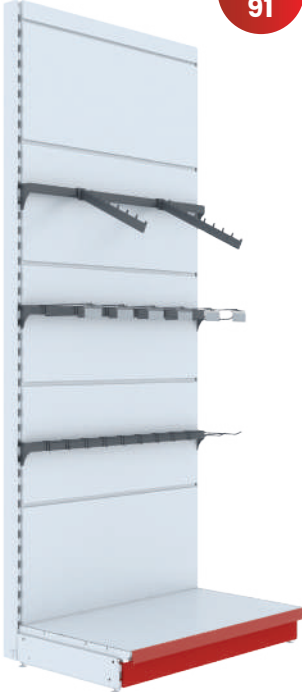

Askı Telli Reyon / Rayon with Strap Wire

Ölçü / Size

H: 1430-1730-2230 L: 600-700-800-900-1000

HAS
203

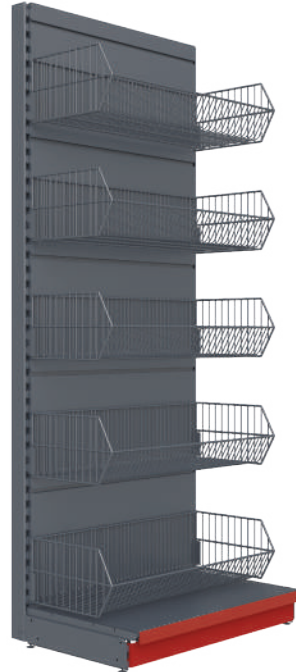

Sepet Rafıli Reyon / Basket Shelves

Ölçü / Size

H: 1430-1730-2230 P: 300-400-500

L: 600-900

HAS
31



Metal Orta Stand



**HAS
88**

Mini Rack Reyon İçli



Hafif Depo Raf Sistemleri

-  EMNİYET PİMİ
-  ÇELİK DÜBEL
-  AYAK PABUCU



**HAS
35**

AHT Dolap Reyonu







HAS
204

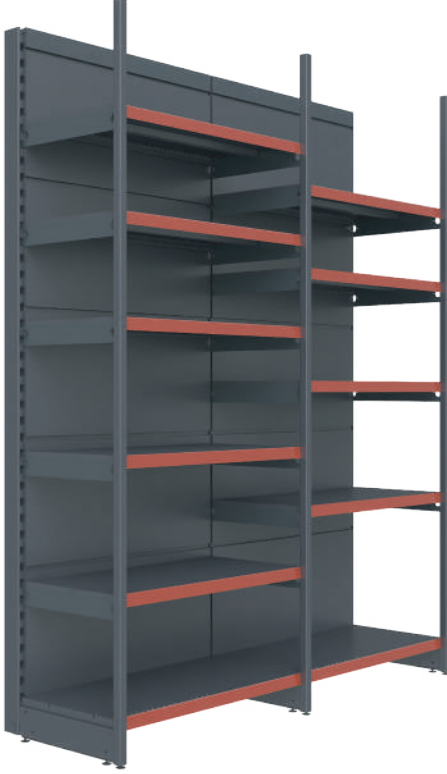

HAS
95

Semirek Çift
Yönlü Reyon



Semirek / Semirek Unit

Ölçü / Size

H: 1430-1730-2230 P: 300-400-500-600

L: 600-700-800-900-1000-1250

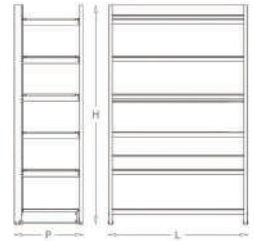



HAS
207

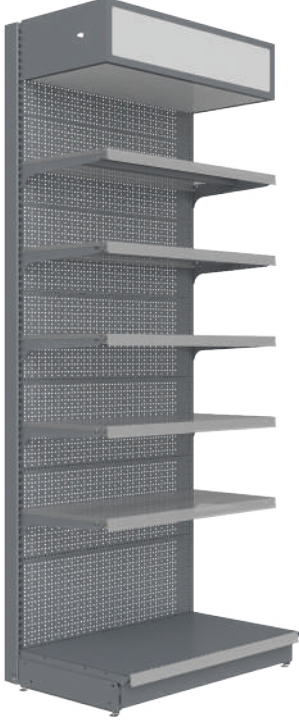

Ölçü / Size	
H: 2230	P: 300-400-500
L: 600-700-800-900-1000	



HAS
52

Alt Ahşap Çekmeceli
Reyon



HAS
51

Kozmetik Primit
Stand







HAS
86

Hafif Depo
Ünitesi



HAS
87

3 Ayaklı Hafif
Depo Ünitesi



Hafif – Mini Rack Raf Sistemleri

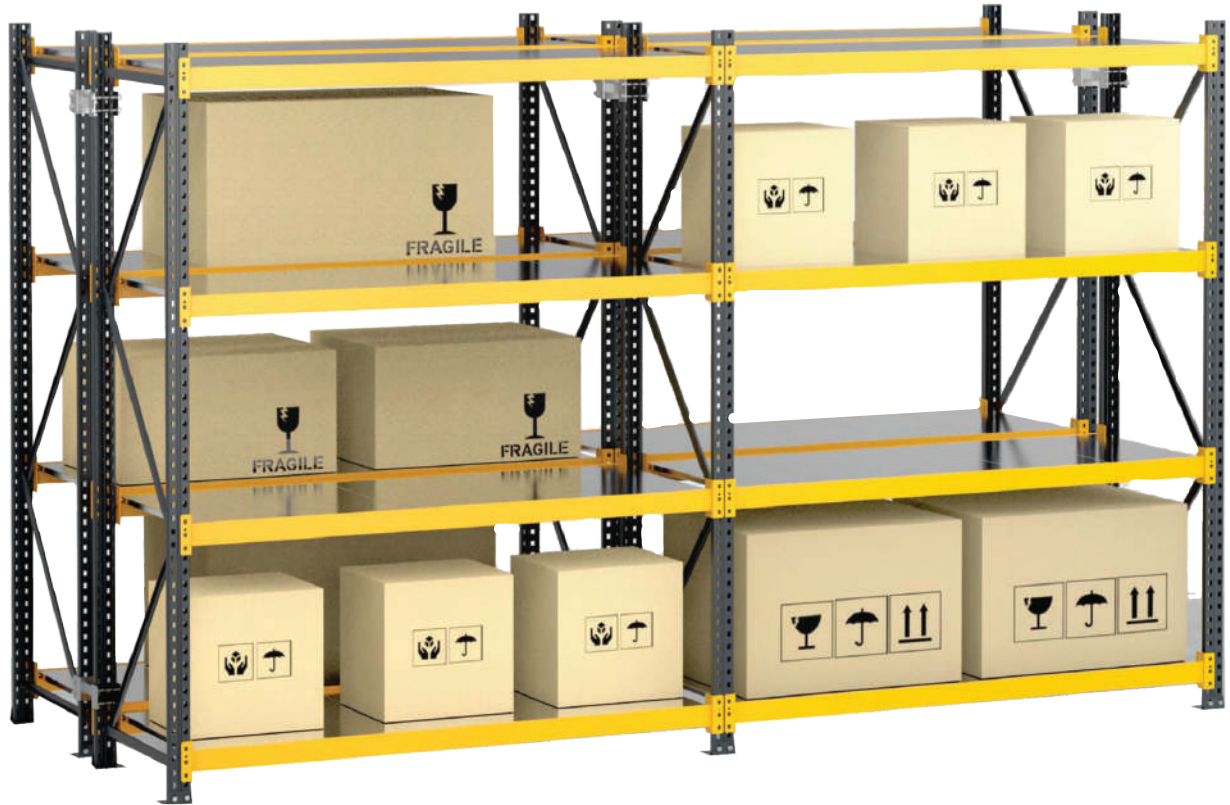

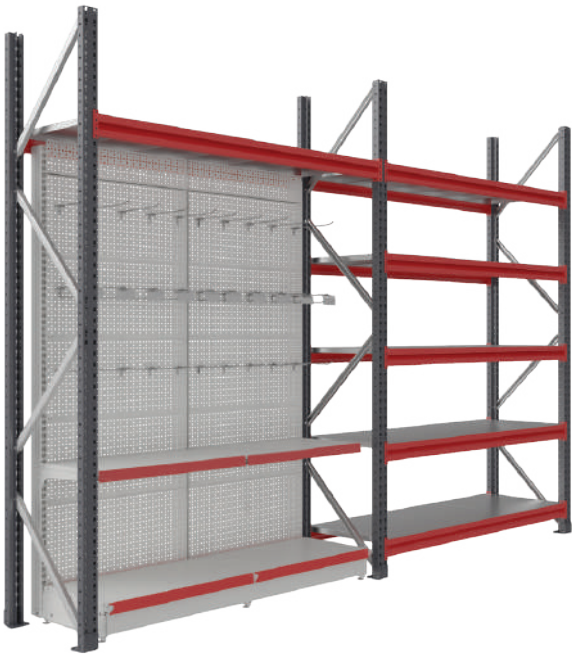
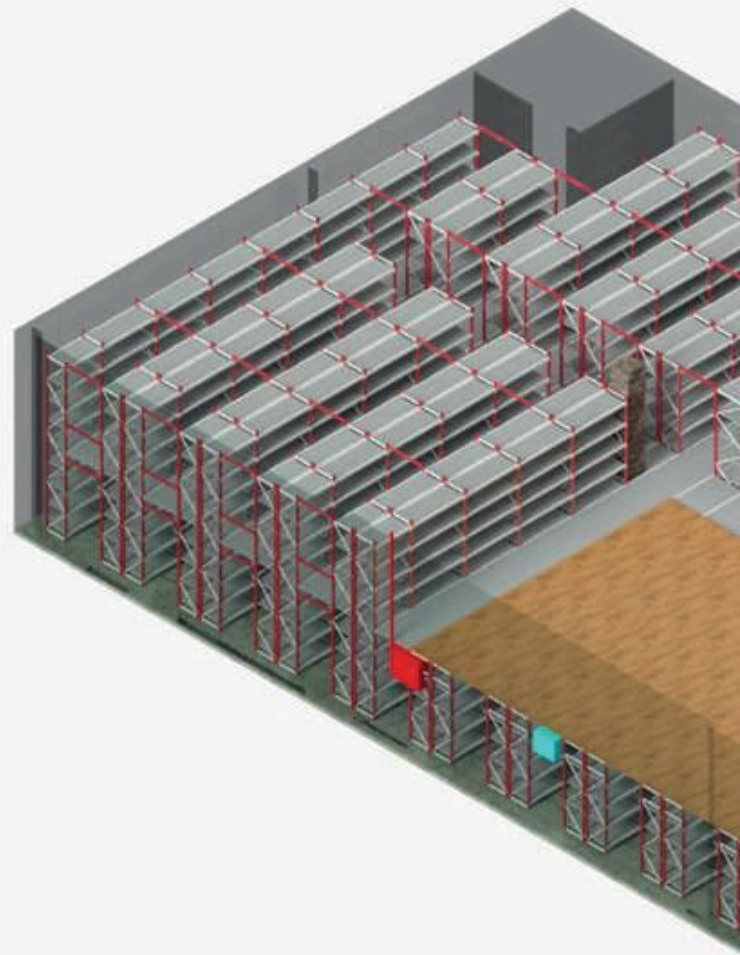

Mezzanine Rack Sistemleri

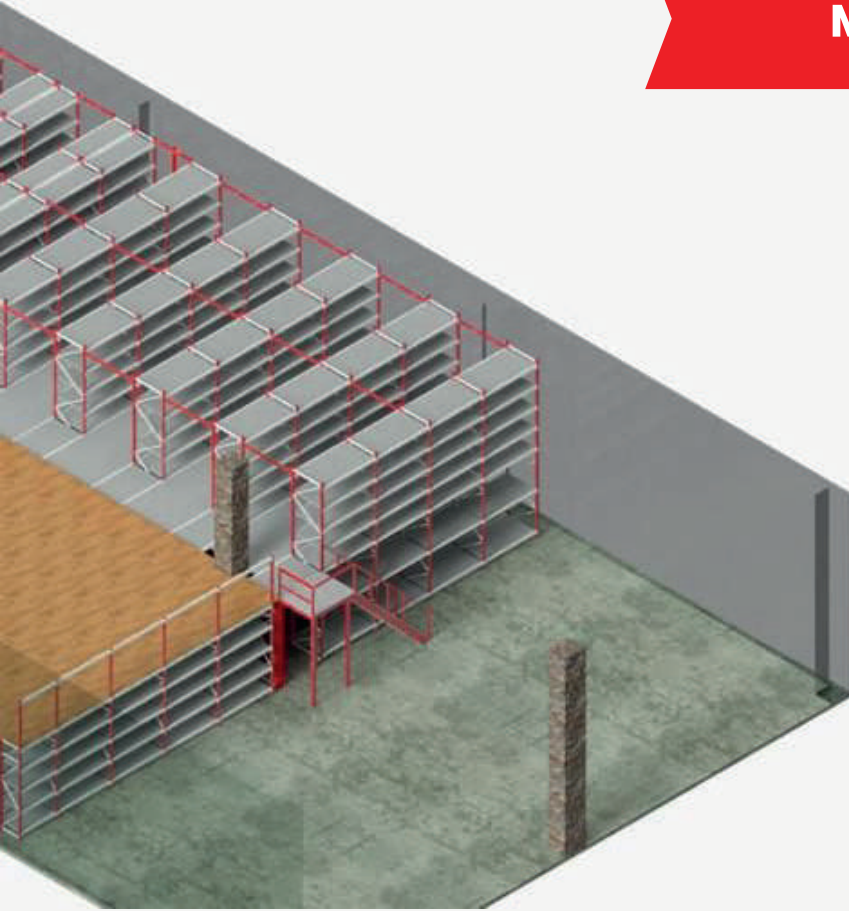

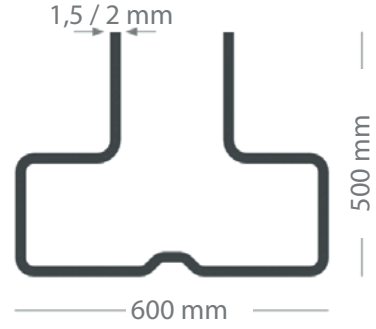
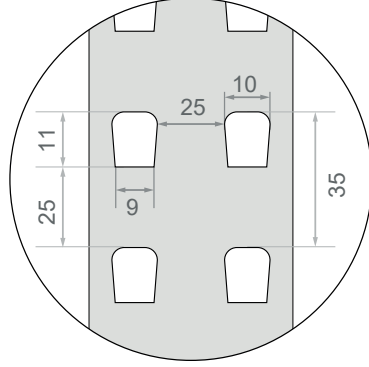
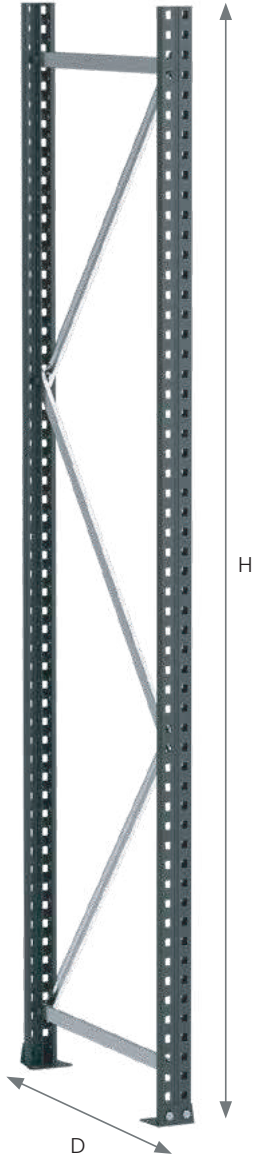

Standart Frame Height (H) mm

2000 - 2250 - 2500 - 2750 - 3000

Standart Frame Depth (D) mm

400 - 500 - 600 - 700 - 800 - 900 - 1000 (SINGLE LEG)

1200 - 1300 - 1400 - 1500 (THREE LEG)

Standart Frame Edges

1,5 - 2 mm



39 x 86 x 71 mm

Travers Çeşitleri ve Taşıma Kapasiteleri

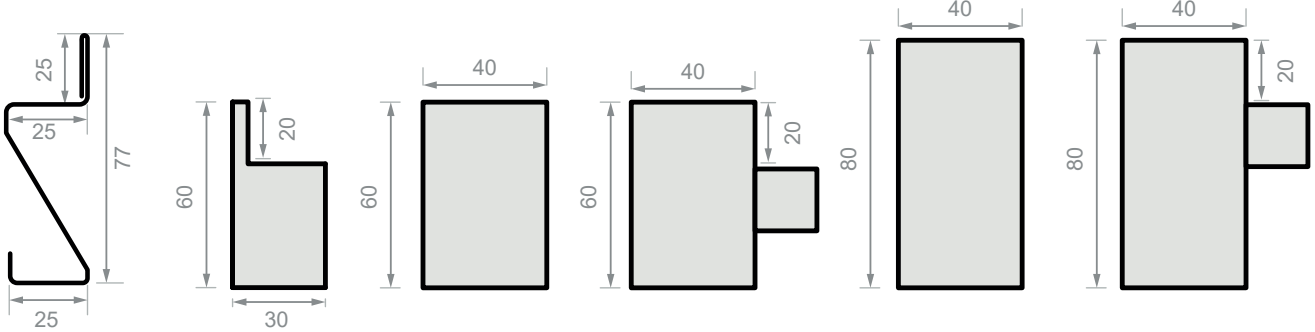

Beam Floor Load Carrying Capacities

Beam Edge	1000 mm	1250 mm	1500 mm	1750 mm	2000 mm	2250 mm	2500 mm
HAS 86 Z BEAM 66. (1,5 mm)	640 Kg	600 Kg	560 Kg	480 Kg	420 Kg		
HAS 86 Z BEAM 66. (2 mm)	810 Kg	760 Kg	710 Kg	600 Kg	550 Kg		
HAS 86 OMEGA BEAM 30x60 (1,5 mm)	1150 Kg	860 Kg	660 Kg	550 Kg	500 Kg	460 Kg	410 Kg
HAS 86 OMEGA BEAM 30x60 (2 mm)	1200 Kg	1060 Kg	840 Kg	700 Kg	620 Kg	580 Kg	560 Kg
HAS 86 BOX BEAM 40x60 (1,5 mm)	1200 Kg	860 Kg	700 Kg	660 Kg	540 Kg	500 Kg	440 Kg
HAS 86 BOX BEAM 40x60 (2 mm)	1340 Kg	1100 Kg	880 Kg	770 Kg	640 Kg	600 Kg	550 Kg
HAS 86 BOX BEAM 40x80 (2 mm)		1900 Kg	1600 Kg	1350 Kg	1200 Kg	1170 Kg	1000 Kg
HAS 86 BOX G BEAM 40x80 (2 mm)		1950 Kg	1650 Kg	1400 Kg	1300 Kg	1250 Kg	1070 Kg

Internal Tray

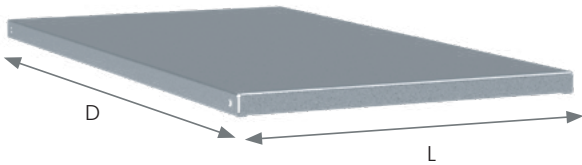

Standart Tray Depth (D) mm

400 - 500 - 600 - 700 - 800 - 900 - 1000 (SINGLE LEG)
1200 - 1300 - 1400 - 1500 (THREE LEG)

Standart Tray Length (L)

250 - 300 mm

External Tray



Standart Tray Height (H)

27 mm

Standart Tray Edges

0,7 - 1 - 1,2 - 1,5 mm

HAS
40

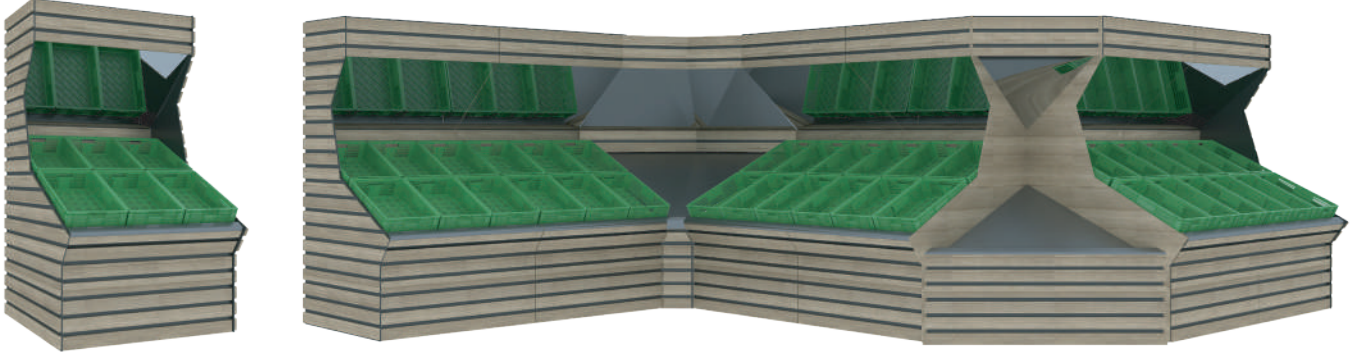

Ağaç Duvar Manav Reyonu / Tree Wall Grocery Store

Ölçü / Size

H: 2223

P: 800-1200

L: 800-1200

HAS
205

HAS
42

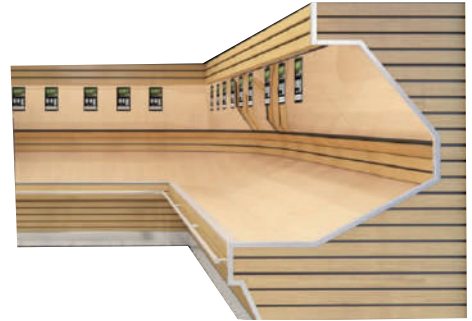
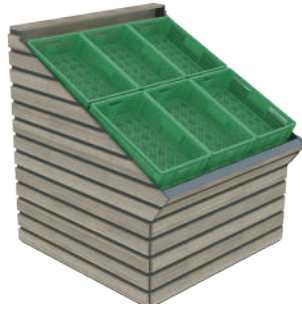

Çift Yönlü Ağaç Manav Reyonu / Two Way Tree Greengrocer

L: 870-1270-1670-2470

P: 800-1200

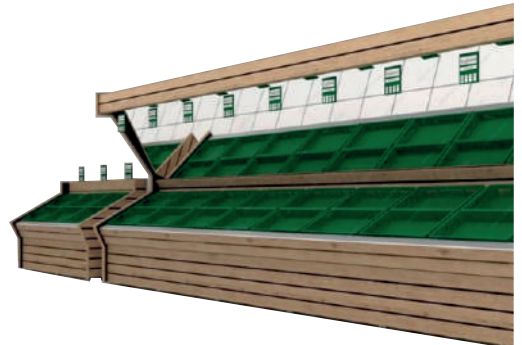



**HAS
44**

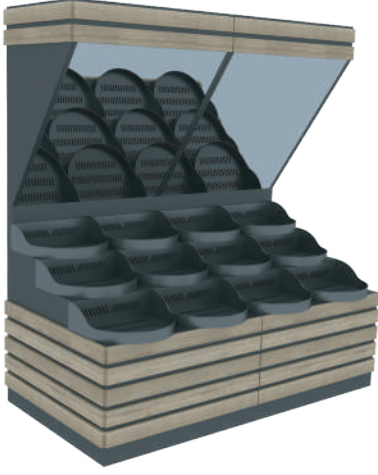

Ağaç Duvar Reyonu Metal Kasalı / Wood Wall Cabinet with Metal Case	
Ölçü / Size	
H: 2223	P: 500-1000
L: 1000	

**HAS
43**

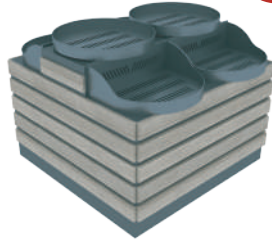

Ağaç Çift Yönlü Metal Kasalı Reyon / Wooden Bidirectional Metal Case Cabinet	
Ölçü / Size	
H: 1000	P: 500-1000
L: 1000	



**HAS
45**

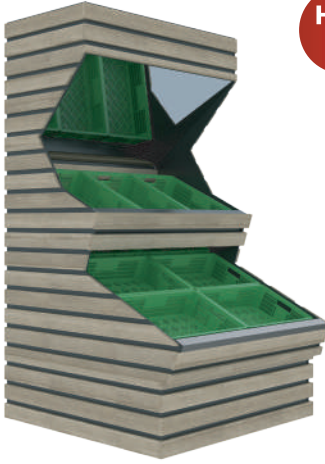

Ağaç Duvar Manav Reyonu İki Türlü / Tree Wall Grocery Store Two Floors	
Ölçü / Size	
H: 2223	P: 1200
L: 1200	

**HAS
46**

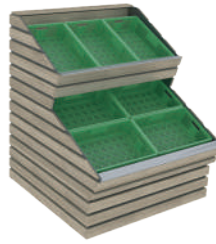

Ağaç İki Yönlü İki Türlü Manav Reyonu / Tree One-Way Two Storey Grocery Store	
Ölçü / Size	
H: 1730	P: 1200
L: 1200	

**HAS
47**



Ağaç Duvar Reyonu Krom Zeminli / Wood Wall Cabinet Chrome Floor	
Ölçü / Size	
H: 2223	P: 500-1000
L: 1000	

**HAS
206**



Berlin Manav Reyonu / Berlin Grocery Store	
Ölçü / Size	
H: 2223	P: 1200
L: 900	

**HAS
228**



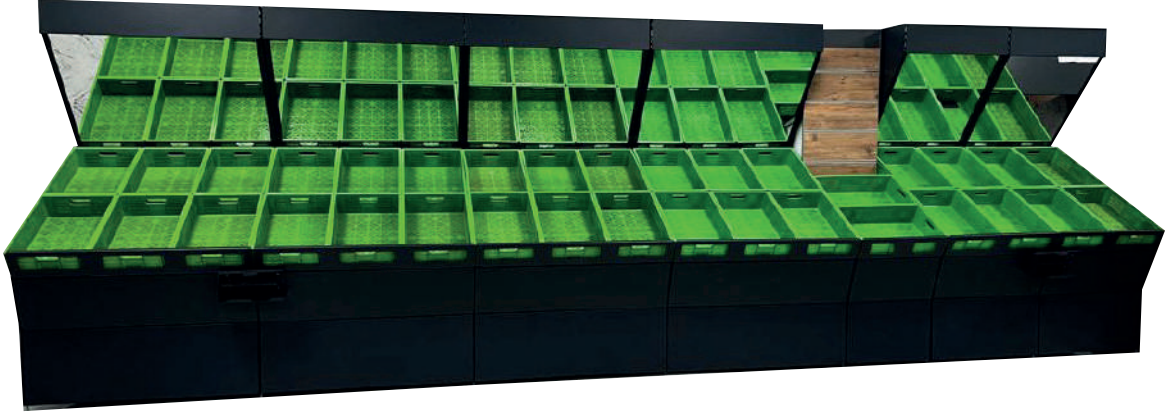

HAS
208

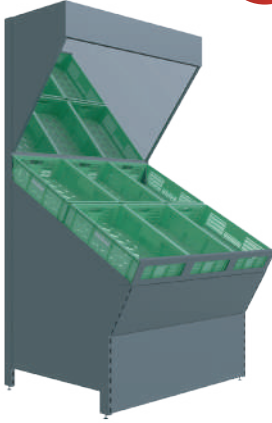

Metal Duvar Manav Reyonu / Metal Wall Grocery Store	
Ölçü / Size	
H: 2223	P: 800-1200
L: 800-1200	

HAS
96



**Tel Raflı
Manav Reyonu
(Seyyar)**

HAS
70



**Çift Yönlü
Metal Manav Reyonu**

HAS
97



Yıldız Manav

HAS
98

**Lazer
Manav
Reyonu**



HAS
229

**Ventu
Orta
Manav**



HAS
71

Manav Etiketliği

HAS
41

**40x60
Manav Sepeti**



HAS
169

Tekli Poşetlik

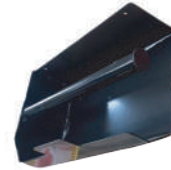

HAS
100

**Çiftli
Poşetlik**





HAS
60

Tekerlekli Orta Stand



HAS
61

Ağaç Gondol Başlı Reyon

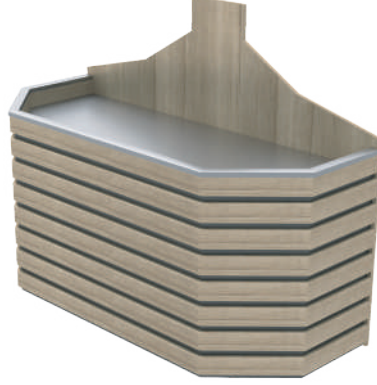

HAS
62

Oval Ağaç Gondol Başlı Reyon



HAS
170

Sekizgen Orta Stand



HAS
65

Dörtlü Orta Stand

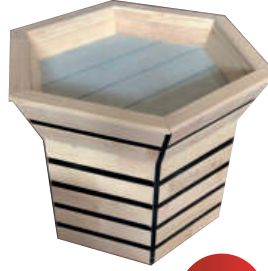

HAS
66

Katlı Orta Stand



HAS
67



HAS
64

Ağaç Orta Stand

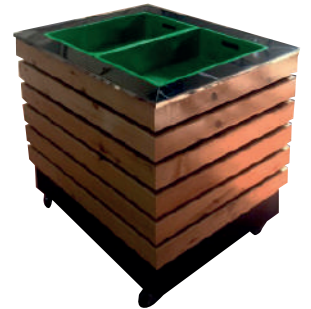

HAS
68

Double Terazi Bankosu

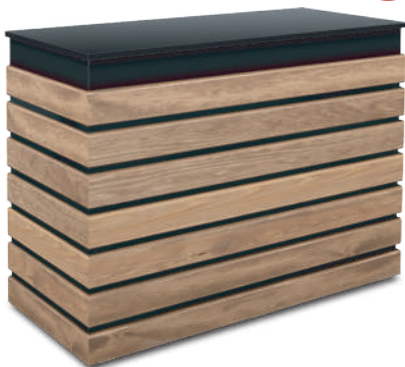

HAS
69

Kollu Terazi Bankosu





HAS
48

Ahşap
Ekmek
Reyonu



HAS
1

Ela
Ekmek
Reyonu



HAS
131

Dolaplı
Ekmek
Reyonu



HAS
173

Rafli
Ekmek
Reyonu



HAS
136

Rafli
Ekmek
Reyonu



HAS
174

Flexi Dolaplı
Ekmek Reyonu



HAS
130

Flexi Ekmek
Reyonu





**HAS
134**

**Izgaralı Ekmek
Reyonu**



**HAS
137**

**Paketli Ekmek
Reyonu**

**HAS
138**

**Bakery Ekmek
Reyonu**



**HAS
139**

**Açık Ekmek
Reyonu**





HAS
175

Güven Züccaciye
Reyonu



HAS
177

Piramit Orta
Reyon



HAS
176

Zigon Sehpa

Züccaciye Reyonları



HAS
178

Güven Model Züccaciye
Alt Ahşap Çekmeceli Reyon



HAS
179

Orta Güven Model Züccaciye
Alt Ahşap Çekmeceli Reyon



HAS
180



HAS
181



HAS
230



HAS
188



HAS
232



HAS
184



HAS
185



HAS
233



HAS
186



HAS
187

Kolon
Kaplama

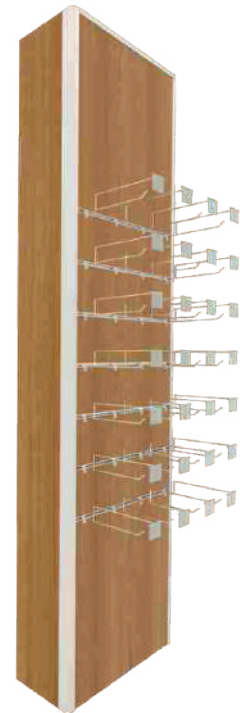

HAS
234

Halı Stand





HAS
183



HAS
189

Derinlikli Orta Reyon



HAS
190

Derinlikli Orta Reyon



HAS
192

Asmalı ve Rafli Orta Stand



HAS
193

Dökme ve Dolaplı Orta Stand



HAS
231

Araba Reyonu



HAS
194

Fonksiyonlu Orta Stand



HAS
93

Bisiklet Reyonu









HAS
195

**Bakliyat
Reyonu**





**HAS
99**

Baharat Reyonu



**HAS
101**

**Orta Baharat
ve Bakliyat
Standı**

**HAS
102**

**Orta atılı
Reyon**



HAS
103

Kapalı Çerez Reyonu



HAS
105

Açık ve Kapalı Çerez Reyonu



HAS
104

Fonksiyonlu Bakliyat ve Kuruyemiş Reyonu



HAS
107

Fleksi Kutulu Reyon



HAS
106

Şekerleme Reyonu







HAS
108

**Taçlı Kırtasiye
Reyonu**



HAS
109

**Aksesuar Taçlı
Kırtasiye Reyonu**



HAS
110

**Taçlı Kanallı
Pano**



HAS
111

**Taçlı Kitap
Reyonu**



**HAS
112**

**Defter
Reyonu**



**HAS
113**

**Radüslü
Kitap
Reyonu**



www.hasraf.com

36

Kirtasiye Reyonları



HAS
114

**Roman Kitap
Reyonu**



HAS
115

**Kitap
Reyonu**



HAS
116

**Yan Görünümlü
Kitap Reyonu**



HAS
117

**Alt Dergilikli
Kitap Reyonu**

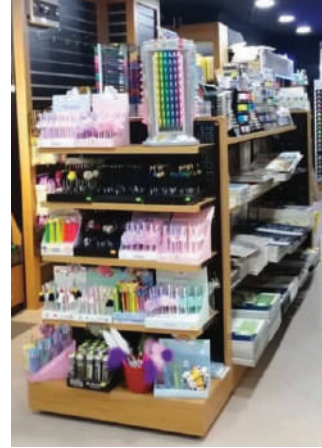

HAS
118

**Orta Dergilik
Reyonu**

HAS
119

**Orta Cd ve
Roman Reyonu**





HAS
120

**Kitap
Reyonu**



HAS
121

**Dörtgen Orta
Reyon**



HAS
122

**Ayarlanabilir Orta
Reyon**



HAS
116

**Radüslü Orta
Kitap Reyonu**



HAS
124

Dergi Reyonu





HAS
125

Fonlu Karton Standı



HAS
126

Fonlu Karton Standı



HAS
127

Karton Standı

HAS
128

Orta Kalem Standı



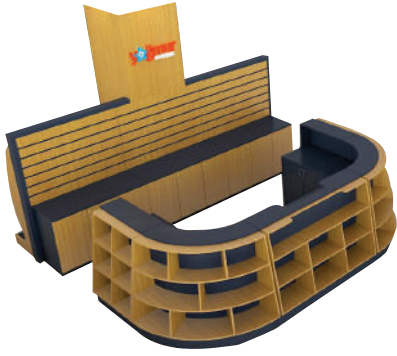

**HAS
197**

Velux Yenbu Banko



**HAS
198**

Etejerli Banko



**HAS
199**

Yenbu Banko



**HAS
132**

Dizayn Banko Masası



**HAS
133**

Expres Banko

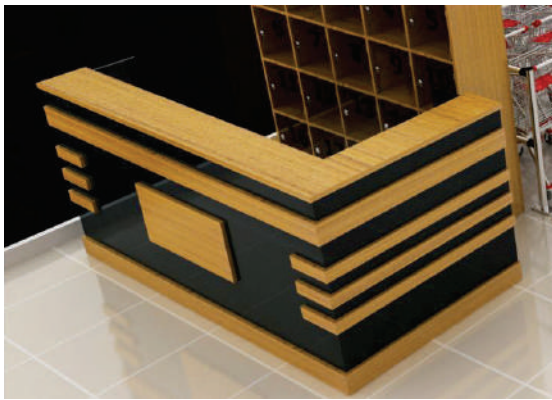
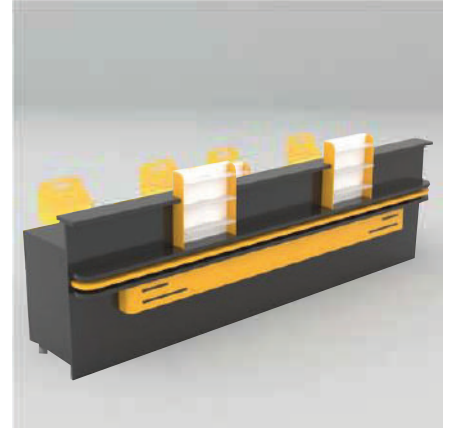

**HAS
200**

L Banko Masası



**HAS
201**

Ada Model

**HAS
204**

Velux Double Bantlı



**HAS
212**

Oval Velux Double Bantlı



**HAS
210**

Velux Double



**HAS
211**

Velux Bantlı



**HAS
213**

Oval Velux Bantlı



**HAS
214**

Mini Jet

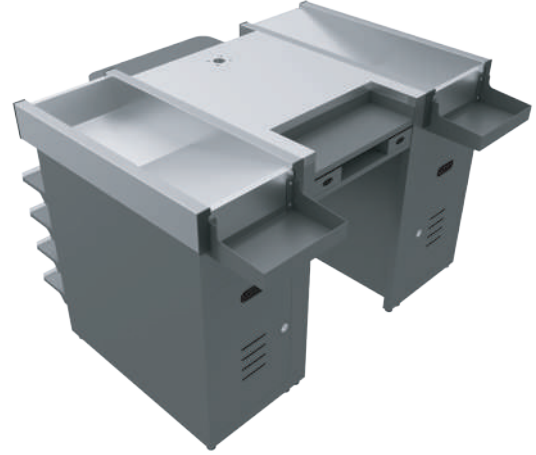
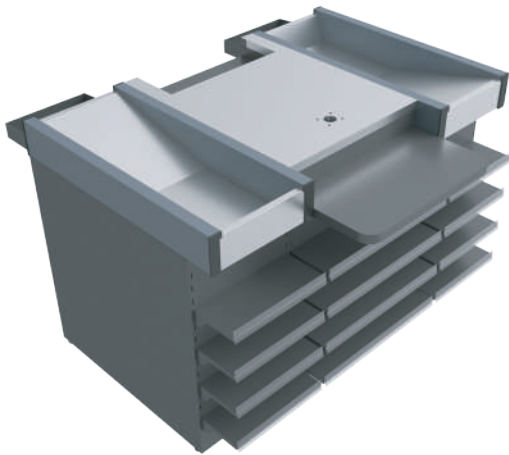

Sağ/Right

Sol/Left

Bantlı/With Transport Band

Bantsız/Without Transport Band

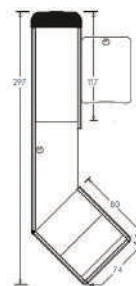
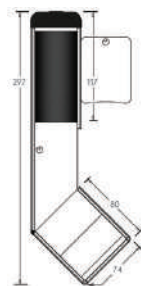



**HAS
215**

U - Tipi Ekspres

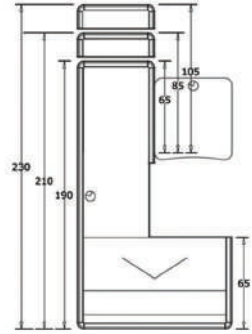
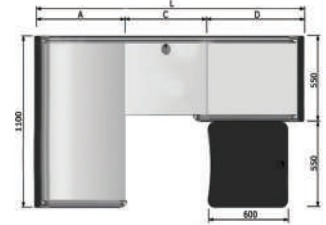
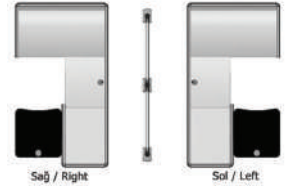

**HAS
216**

U - Tipi Ekspres Bantlı

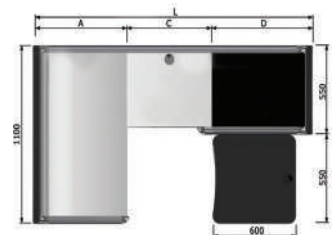
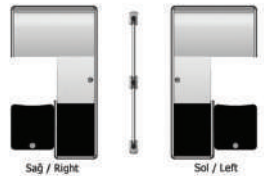
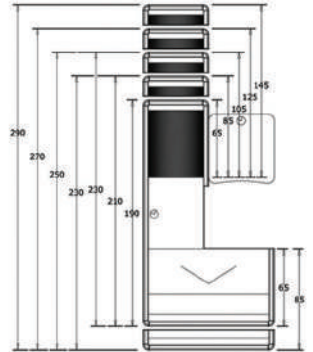



HAS
71

Tendom Express

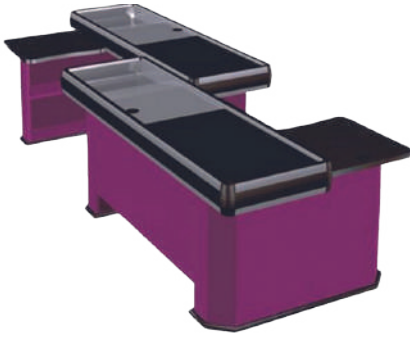

HAS
217

Tendom Bantlı Express

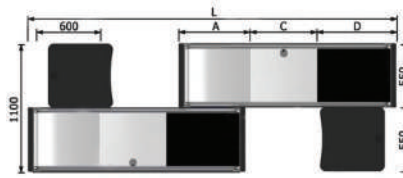

HAS
218

L - Tipi Express



HAS
219

Vizyon Express

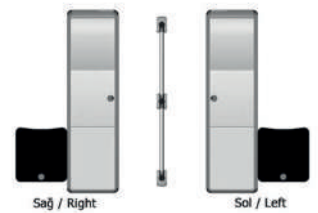
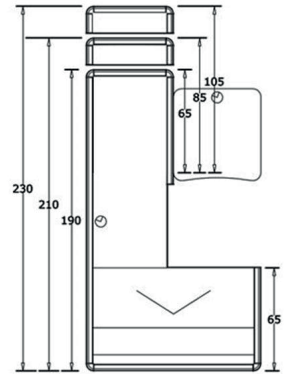



**HAS
220**

Miles Bantlı

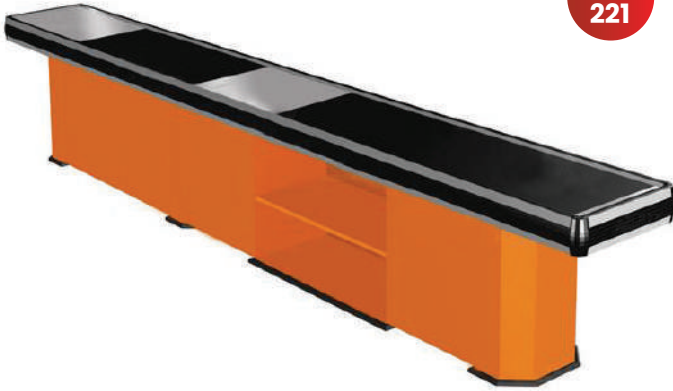

**HAS
221**

L - Tipi Miles Bantlı

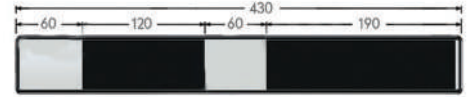
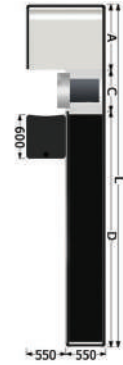

**HAS
222**

Miles Double Bantlı

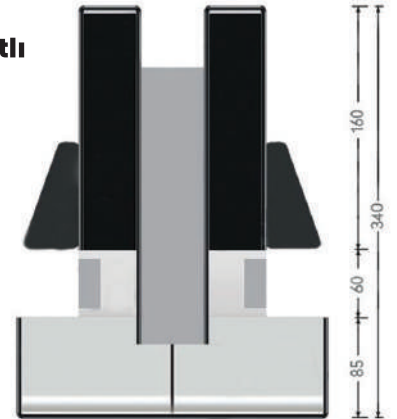

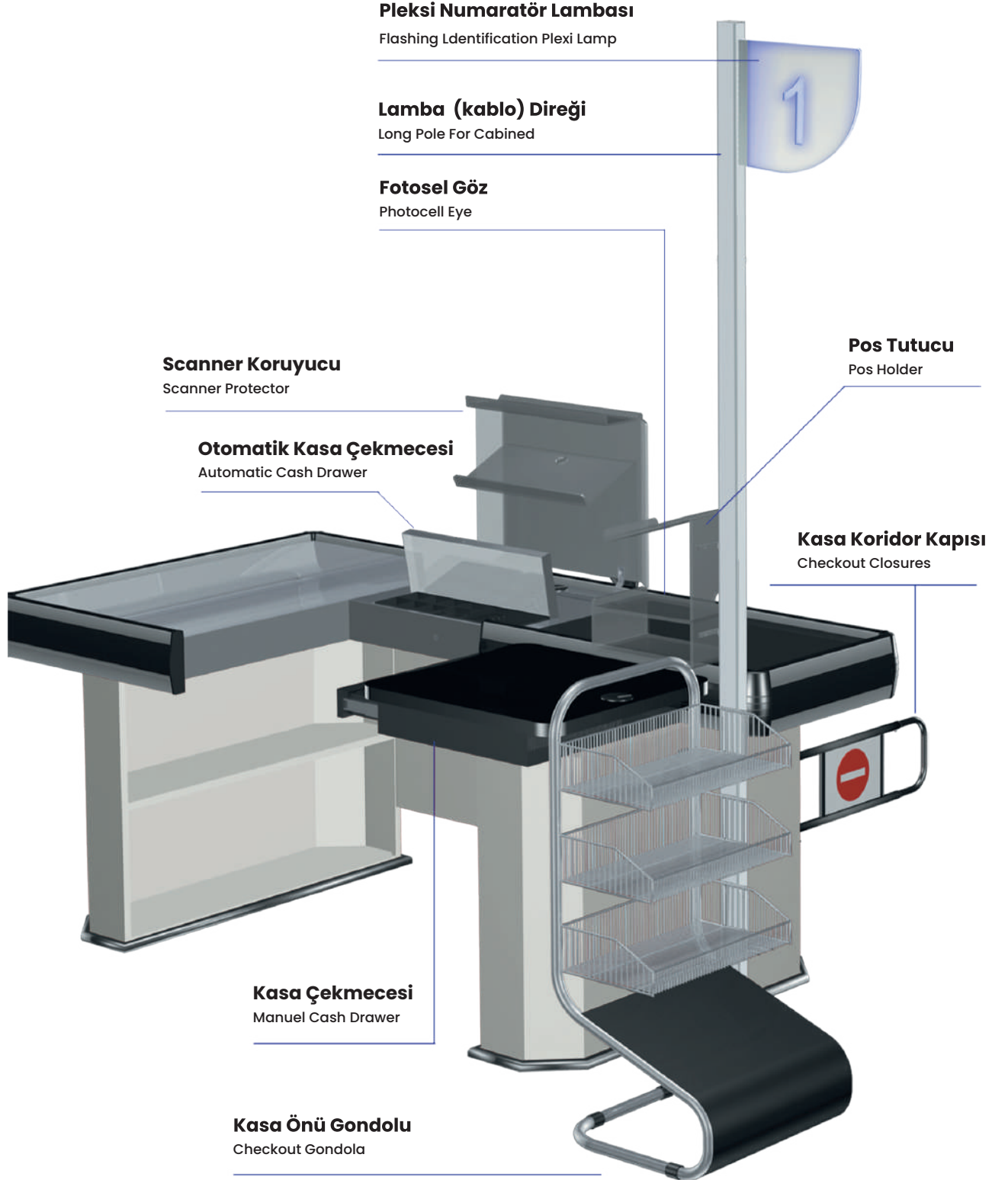

Yazar Kasa Aksesuarları



**HAS
141**

Kasa Önü Reyonu

H: 110
P: 62
L: 60



**HAS
143**

Poşet Arabası

H: 72
P: 75
L: 38



**HAS
145**

Turnike

H: 20
P: 50 <-> 80 cm arası
L: -



**HAS
147**

Katlı Poşetlik

H: 56
P: 13
L: 40



**HAS
149**

Kablo Direği

H: 280
P: 6
L: 6



**HAS
142**

Para Çekmecesi

H: 9
P: 17
L: 46



**HAS
144**

Kasa Önü Reyonu

H: 123
P: 40
L: 100



**HAS
146**

Para Çekmecesi

H: 9
P: 45
L: 51

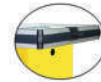

**HAS
148**

Poşetlik

H: 18
P: 6
L: 15



**HAS
150**





HAS 132 Yan Dikeçli Turnike

H: 117

P: 245

L: 213

HAS 84 Çiftli Çarpma Turnike



HAS 85 Tekli Çark Turnike



H: 107

P: -

L: 78

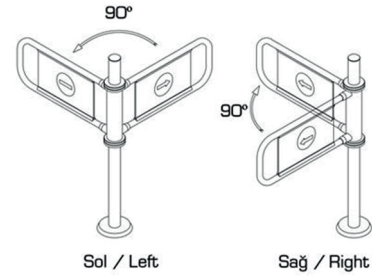

HAS 86 Turnike



H: 106

P: 105

L: 150

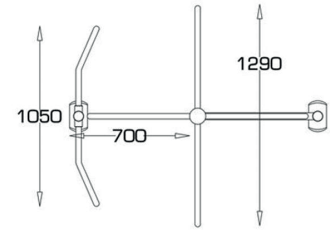

HAS 87 -L- Ara Boru Bariyer



HAS 88 Market Arabası Bariyer



	Kod / Code	Ölçü / Size
01	Tek Yönlü Dikeç / Single Side Upright	1060x180x110
02	Köşe Dikeç / Corner Upright	1060x180x110
03	Çift Yönlü Dikeç / Double Side Upright	1060x180x110
04	Bariyer Ara Boru / Barrier Connecting Pipe	40

	Kod / Code	Ölçü / Size
B1	Yer Bariyeri Bağlantı Elemanı / Floor Barrier Connection Elements	170 3020 015+
B2	Yer Bariyeri Profili / Floor Barrier Profile	170 3010 004+
B3	Yer Bariyer Bitim / Floor Barrier End	170 3040 004+

Turnike ve Bariyer Sistemleri



HAS
58

Delikli Panel
Askı Çubuğu



HAS
228

Etiketli Askı
Çubuğu



HAS
59

Kanallı Panel
Askı Çubuğu



HAS
225

Etiketli Askı
Çubuğu



HAS
151

Kanala Geçen
Top Aparatı



HAS
152

Perdeye Geçen
Top Aparatı



HAS
226

U - Askılık



HAS
153

Ön Sperlik



HAS
227

Kutu Profil
Askılık



HAS
57

Pimli Askılık



HAS
154

Sepet Raf



HAS
155

Fiyat Etiketliği



HAS
155



HAS
155

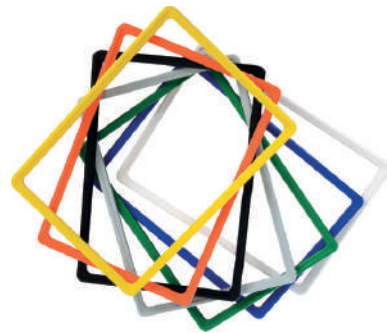

Standart

Market Arabası / Shopping Trolley



75 LT ✓

100 LT ✓

130 LT

150 LT

180 LT

210 LT



100 LT ✓

130 LT

150 LT

Alt Aparatlı

Market Arabası / Shopping Trolley

70 LT

130 LT

160 LT ✓



Aparatlı

Market Arabası / Shopping Trolley

100 LT ✓

130 LT

150 LT ✓



El Sepetleri ve Plastik Araba



Plastik
Market Arabası / Shopping Trolley



100 LT

Junior
Market Arabası / Shopping Trolley



25 LT

Plastik El Sepeti
Market Sepeti / Market Basket



22 LT

Metal El Sepeti
Market Sepeti / Market Basket



Çek Çek El Sepeti
Market Sepeti / Market Basket



43 LT

El Sepet Altlığı
Market Sepeti / Market Basket



**HAS
156**

Derinlik Ayarlı Havuz Sepet



H: 86
P: 60 - 80
L: 60 - 80 - 120

**HAS
157**

4 Katlı Aksiyon Sepet



H: 165
P: 50
L: 70 - 100

**HAS
158**

Çift Katlı Havuz Sepet



H: 86 P: 60 - 80 L: 80 - 120

**HAS
159**

Derinlik Ayarlı Tekerlekli Sepet



H: 86 P: 80 L: 120

**HAS
160**

Çift Yönlü Derinlik Ayarlı Havuz Sepet



H: 150 P: 100 L: 120

**HAS
161**

Çift Katlı Havuz Sepet



Üst Kat Aparatı 26 Promotion Basket Level Apparatus 26	
Kod / Code	Ölçü / Size
	860x260x800
	860x260x1200

Üst Kat Aparatı 32 Promotion Basket Level Apparatus 32	
Kod / Code	Ölçü / Size
	420x320x800
	420x320x1200

Çift Katlı Havuz Sepet Double Levelled Promotion Basket	
Kod / Code	Ölçü / Size
	860x600x800
	860x800x1200

**HAS
162**





**HAS
163**

Yük Arabası Tip-1

H: 102

P: 90

L: 60



**HAS
164**

Yük Arabası Tip-2

H: 98

P: 124

L: 72



**HAS
165**

Yük Arabası Tip-3

H: 95

P: 85

L: 55



**HAS
166**

Yük Arabası Tip-4A

H: 95

P: 85

L: 55



**HAS
167**

Yük Arabası Tip-4B

H: 95

P: 85

L: 55

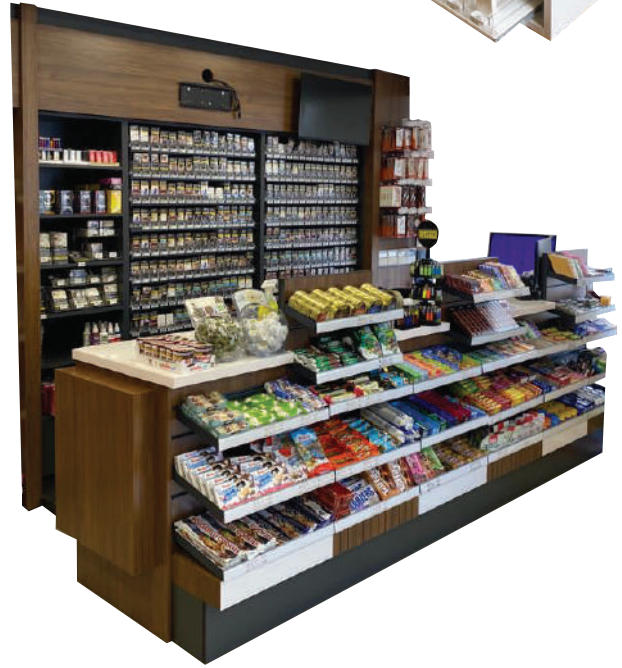

Petrol Reyon Üniteleri



H A S **R A F**®



QR OKUT / E-KATALOG İNDİR!



QR OKUT / WEB SİTESİNE GİT!

HASRAF®

www.hasraf.com

Olursa rafınız HAS'ından olsun...

 [hasrafmetal](https://www.instagram.com/hasrafmetal)

 www.hasraf.com

 Has Raf

 info@hasraf.com

 Fax: (0342) 235 6421

 Tel: (0342) 235 4111

 K sget  rnek Sanayi Sitesi 6 Nolu Cd. No:16
ŒEHİTKAMİL/ GAZİANTEP / T RKİYE

QR OKUT
E- KATALOG
İNDİR!



QR OKUT
KONUMA
GİT!



QR OKUT
WEB SİTESİNE
GİT!

